

CONECTORES DUPLEX / DUPLEX CONNECTORS / RACCORDS DUPLEX

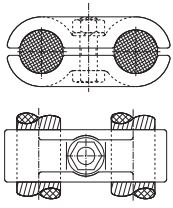

U.6

➤ Pag. F1

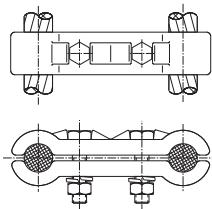

UD

➤ Pag. F1

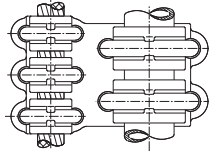

UBC

➤ Pag. F1

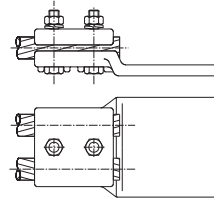

R2CP

➤ Pag. F2

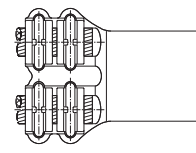

R2CP1

➤ Pag. F2

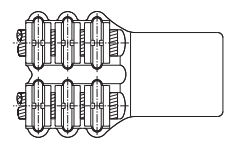

R2CP3

➤ Pag. F3

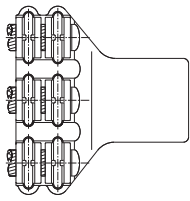

R3CP

➤ Pag. F3

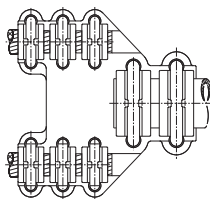

RD3B

➤ Pag. F4

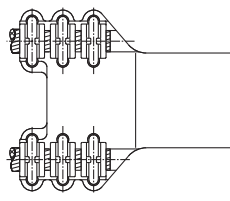

RD3P

➤ Pag. F4

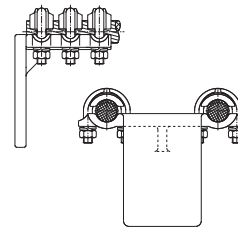

LD3P

➤ Pag. F5

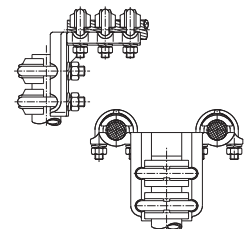

LD3B

➤ Pag. F5

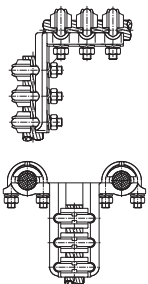

LD3C

➤ Pag. F6

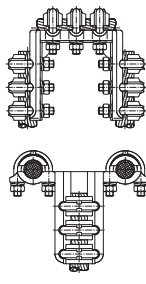

LDX3C

➤ Pag. F6

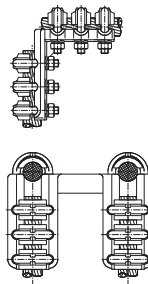

LDD3C

➤ Pag. F7

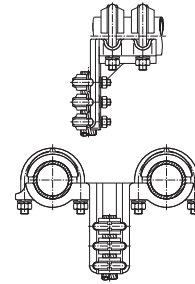

LDBC3

➤ Pag. F7

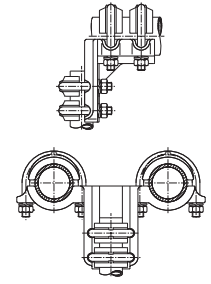

LDBB

➤ Pag. F8

DUPLEX CONNECTOR

CONECTOR DUPLEX

RACCORD DUPLEX

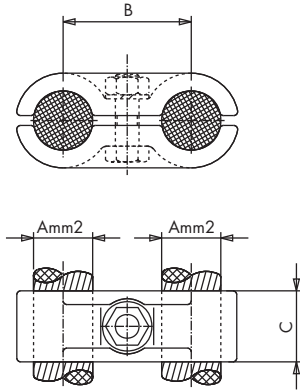

U.6

Referencia Code Référence	mm ² A	mm			Par de apriete Tightening torque Couple de serrage (kg.m)
		B	C		
U.6-250	180-250	60	35		5
U.6-400	300-400	60	35		5
U.6-500	500	60	35		5

SPACER DUPLEX CU. CABLE

SEPARADOR CABLE DUPLEX CU.

ENTRETOISE CABLE DUPLEX CU.

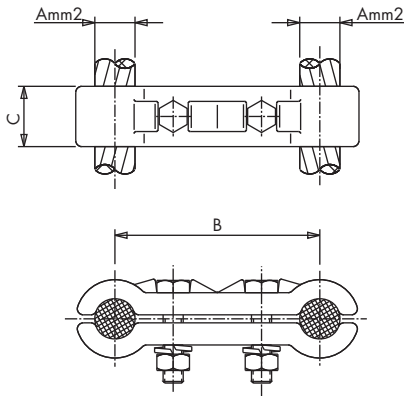

UD

Referencia Code Référence	mm ² A	mm			Par de apriete Tightening torque Couple de serrage (kg.m)
		B	C		
UD.1-250	180-250	100	30		3
UD.1-400	300-400	100	30		3
UD.1-500	500	100	30		3
UD.15-250	180-250	150	30		3
UD.15-400	300-400	150	30		3
UD.15-500	500	150	30		3

PARALLEL CONNECTOR FOR CU. TUBE AND CU. CABLE

CONECTOR PARALELO PARA TUBO CU. Y CABLE CU.

BLOC DOUBLEMENT POUR TUBE CU. ET CABLE CU.

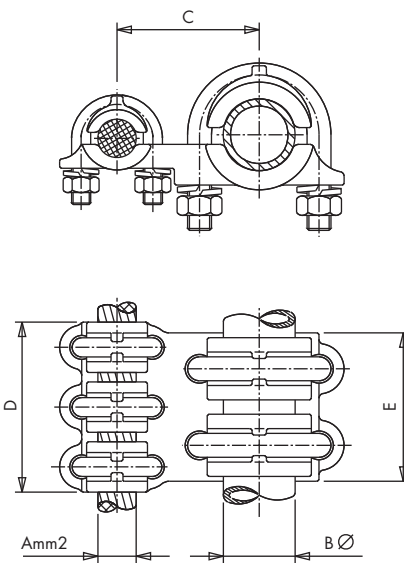

UBC

Referencia Code Référence	mm ² A	mm				Par de apriete Tightening torque Couple de serrage (kg.m)	
		Bø	C	D	E	A	B
UBC-30150	95-150	30	64	73	62	2	3
UBC-30250	180-250	30	66	80	62	2	3
UBC-30400	300-400	30	70	85	62	2	3
UBC-30500	500	30	76	94	62	3	3
UBC-40150	95-150	40	69	73	67	2	3
UBC-40250	180-250	40	71	80	67	2	3
UBC-40400	300-400	40	75	85	67	2	3
UBC-40500	500	40	81	94	67	3	3
UBC-50150	95-150	50	77	73	75	2	3
UBC-50250	180-250	50	79	80	75	2	3
UBC-50400	300-400	50	83	85	75	2	3
UBC-50500	500	50	89	94	75	3	3
UBC-60150	95-150	60	82	73	80	2	3
UBC-60250	180-250	60	84	80	80	2	3
UBC-60400	300-400	60	88	85	80	2	3
UBC-60500	500	60	94	94	80	3	3

DUPLEX CONNECTOR CU. CABLES TO CU. FLATBAR

CONECTOR DUPLEX CABLES CU. A PLETINA CU.

RACCORD DUPLEX CABLES CU. À BARRE MÉPLATE CU.

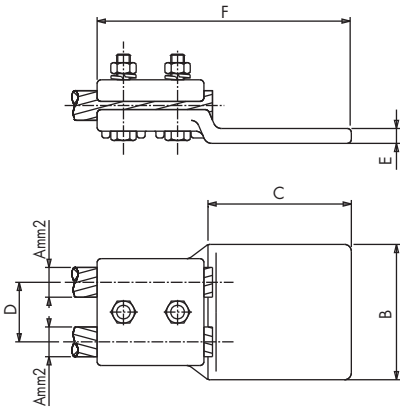

R2CP

Referencia Code Référence	mm ²	mm					Par de apriete Tightening torque Couple de serrage (kg.m)
		A	B	C	D	E	
R2CP-15055	95-150	80	80	40	10	185	3
R2CP-15066	95-150	100	100	40	10	185	3
R2CP-25055	180-250	80	80	40	10	185	3
R2CP-25066	180-250	100	100	40	10	185	3
R2CP-40055	300-400	80	80	40	10	185	3
R2CP-40066	300-400	100	100	40	10	185	3

DUPLEX CONNECTOR CU. CABLES TO CU. FLATBAR

CONECTOR DUPLEX CABLES CU. A PLETINA CU.

RACCORD DUPLEX CABLES CU. À BARRE MÉPLATE CU.

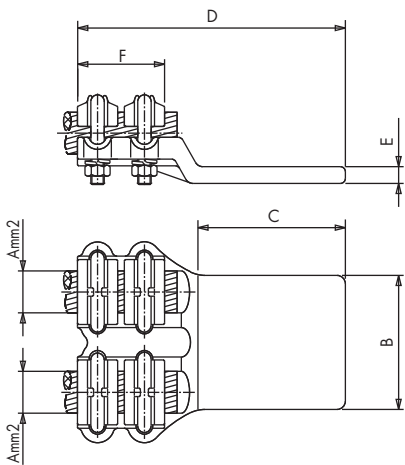

R2CP1

Referencia Code Référence	mm ²	mm					Par de apriete Tightening torque Couple de serrage (kg.m)
		A	B	C	D	E	
R2CPI-15044	95-150	60	60	120	8	47	2
R2CPI-15055	95-150	80	80	160	8	47	2
R2CPI-15066	95-150	100	100	160	8	47	2
R2CPI-25044	180-250	60	60	127	9	52	2
R2CPI-25055	180-250	80	80	167	9	52	2
R2CPI-25066	180-250	100	100	167	9	52	2
R2CPI-40044	300-400	60	60	150	10	55	2
R2CPI-40055	300-400	80	80	170	10	55	2
R2CPI-40066	300-400	100	100	170	10	55	2
R2CPI-50044	500	60	60	140	10	62	3
R2CPI-50055	500	80	80	180	10	62	3
R2CPI-50066	500	100	100	180	10	62	2

DUPLEX CONNECTOR CU. CABLES TO CU. FLATBAR

CONECTOR DUPLEX CABLES CU. A PLETINA CU.

RACCORD DUPLEX CABLES CU. À BARRE MÉPLATE CU.

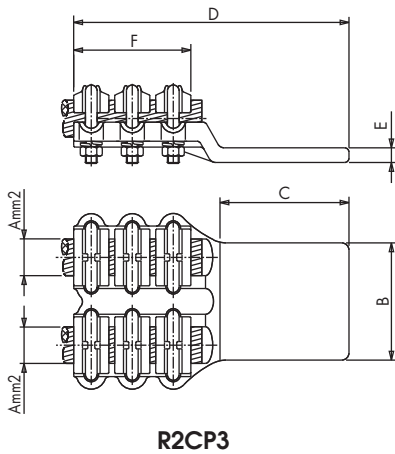

R2CP3

Referencia Code Référence	mm ²	mm					Par de apriete Tightening torque Couple de serrage (kg.m)
		A	B	C	D	E	
R2CP3-15044	95-150	60	60	152	8	73	2
R2CP3-15055	95-150	80	80	186	8	73	2
R2CP3-15066	95-150	100	100	186	8	73	2
R2CP3-25044	180-250	60	60	155	9	80	2
R2CP3-25055	180-250	80	80	195	9	80	2
R2CP3-25066	180-250	100	100	195	9	80	2
R2CP3-40044	300-400	60	60	160	10	85	2
R2CP3-40055	300-400	80	80	200	10	85	2
R2CP3-40066	300-400	100	100	200	10	85	2
R2CP3-50044	500	60	60	172	10	94	3
R2CP3-50055	500	80	80	212	10	94	3
R2CP3-50066	500	100	100	212	10	94	3

STRAIGHT CONNECTOR FOR 3 CU. CABLES TO FLATBAR

CONECTOR RECTO PARA 3 CABLES CU. A PLETINA

RACCORD DROIT POUR 3 CABLES CU. À BARRE MÉPLATE

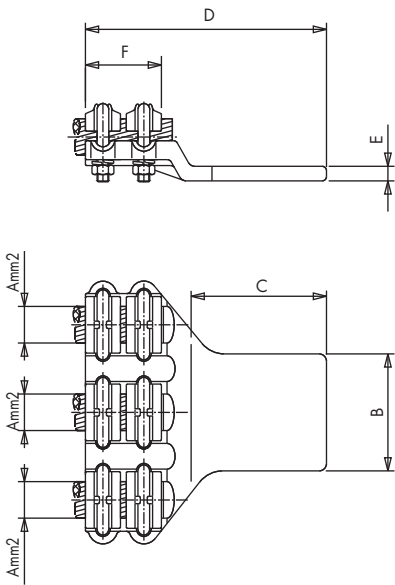

R3CP

Referencia Code Référence	mm ²	mm					Par de apriete Tightening torque Couple de serrage (kg.m)
		A	B	C	D	E	
R3CP-15055	95-150	80	80	160	8	47	2
R3CP-15066	95-150	100	100	160	8	47	2
R3CP-25055	180-250	80	80	167	9	52	2
R3CP-25066	180-250	100	100	167	9	52	2
R3CP-40055	300-400	80	80	170	10	55	2
R3CP-40066	300-400	100	100	170	10	55	2
R3CP-50055	500	80	80	180	10	62	3
R3CP-50066	500	100	100	180	10	62	3



STRAIGHT CONNECTOR DUPLEX CU. CABLE TO CU. TUBE/STUD

CONECTOR RECTO CABLE DUPLEX CU. A TUBO/BORNA CU.

RACCORD DROIT CABLE DUPLEX CU. À TUBE/BORNE CU.

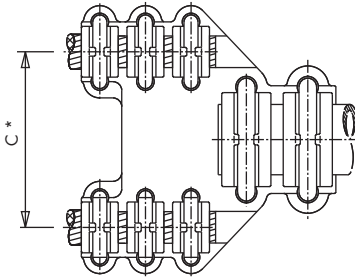
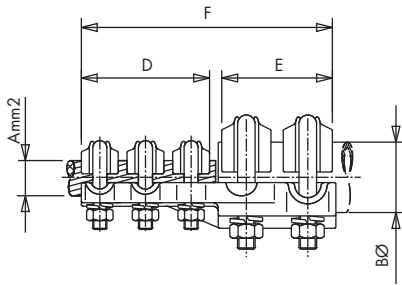

RD3B

Referencia Code Référéce	mm ²	mm					Par de apriete Tightening torque Couple de serrage (kg.m)	
		A	BØ	C*	D	E	F	A
RD3B.* -15030	95-150	30	SEGUN NOTA	73	62	150	2	3
RD3B.* -15040	95-150	40		73	67	155	2	3
RD3B.* -15050	95-150	50		73	75	163	2	3
RD3B.* -15060	95-150	60		73	80	165	2	3
RD3B.* -25030	185-250	30		80	62	157	2	3
RD3B.* -25040	185-250	40		80	67	162	2	3
RD3B.* -25050	185-250	50		80	75	170	2	3
RD3B.* -25060	185-250	60		80	80	175	2	3
RD3B.* -40030	300-400	30		85	62	162	2	3
RD3B.* -40040	300-400	40		85	67	167	2	3
RD3B.* -40050	300-400	50		85	75	175	2	3
RD3B.* -40060	300-400	60		85	80	180	2	3
RD3B.* -50030	500	30		94	62	171	3	3
RD3B.* -50040	500	40		94	67	176	3	3
RD3B.* -50050	500	50		94	75	183	3	3
RD3B.* -50060	500	60		94	80	190	3	3

NOTA: SEPARACION ENTRE CABLES *1=100mm / *15=150mm
 NOTE: SPACE BETWEEN CABLES *1=100mm / *15=150mm
 NOTE: ÉCARTEMENT DES CABLES *1=100mm / *15=150mm

DUPLEX CU. STRAIGHT CONNECTOR TO CU. FLATBAR

CONECTOR RECTO DUPLEX CU. A PLETINA CU.

RACCORD DROIT DUPLEX CU. À BARRE MÉPLATE CU.

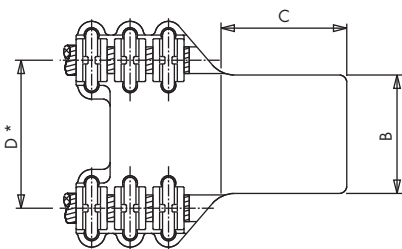
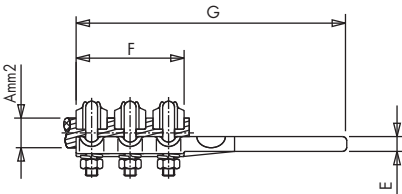

RD3P

Referencia Code Référéce	mm ²	mm						Par de apriete Tightening torque Couple de serrage (kg.m)
		A	B	C	D*	E	F	
RD3P.* -15044	95-150	60	60	SEGUN NOTA	8	73	143	2
RD3P.* -15055	95-150	80	80		8	73	163	2
RD3P.* -15066	95-150	100	100		8	73	183	2
RD3P.* -25044	185-250	60	60		8	80	150	2
RD3P.* -25055	185-250	80	80		8	80	170	2
RD3P.* -25066	185-250	100	100		8	80	190	2
RD3P.* -40044	300-400	60	60		10	85	155	2
RD3P.* -40055	300-400	80	80		10	85	175	2
RD3P.* -40066	300-400	100	100		10	85	195	2
RD3P.* -50044	500	60	60		12	94	164	3
RD3P.* -50055	500	80	80		12	94	184	3
RD3P.* -50066	500	100	100		12	94	204	3

NOTA: SEPARACION ENTRE CABLES *1=100mm / *15=150mm
 NOTE: SPACE BETWEEN CABLES *1=100mm / *15=150mm
 NOTE: ÉCARTEMENT DES CABLES *1=100mm / *15=150mm



L CONNECTOR DUPLEX CU. CABLE TO CU. FLABAR

CONECTOR A 90° CABLE DUPLEX CU. A PLETINA CU.

RACCORD À 90° CABLE DUPLEX CU. À BARRE MÉPLATE CU.

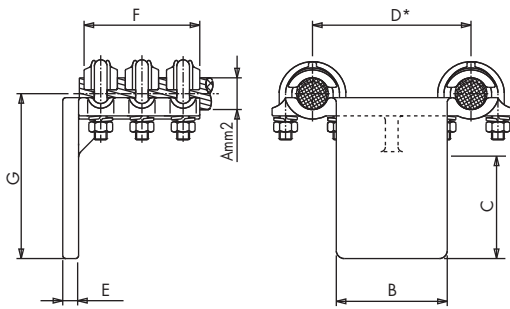

LD3P

Referencia Code Référence	mm ²	mm						Par de apriete Tightening torque Couple de serrage (kg.m)
		A	B	C	D*	E	F	
LD3P.* -15044	95-150	60	60	SEGUN NOTA	8	73	94	2
LD3P.* -15055	95-150	80	80		8	73	114	2
LD3P.* -15066	95-150	100	100		8	73	134	2
LD3P.* -25044	185-250	60	60		8	80	96	2
LD3P.* -25055	185-250	80	80		9	80	116	2
LD3P.* -25066	185-250	100	100		9	80	136	2
LD3P.* -40044	300-400	60	60		10	85	97	2
LD3P.* -40055	300-400	80	80		10	85	117	2
LD3P.* -40066	300-400	100	100		10	85	137	2
LD3P.* -50044	500	60	60		12	94	98	3
LD3P.* -50055	500	80	80		12	94	118	3
LD3P.* -50066	500	100	100		12	94	138	3

NOTA: SEPARACION ENTRE CABLES *1=100mm / *15=150mm

NOTE: SPACE BETWEEN CABLES *1=100mm / *15=150mm

NOTE: ÉCARTEMENT DES CABLES *1=100mm / *15=150mm

L CONNECTOR DUPLEX CU. CABLE TO CU. TUBE/STUD

CONECTOR A 90° CABLE DUPLEX CU. A TUBO/BORNA CU.

RACCORD À 90° CABLE DUPLEX CU. À TUBE/BORNE CU.

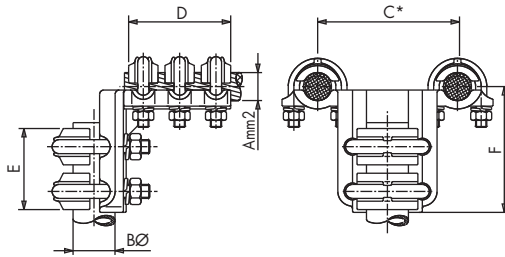

LD3B

Referencia Code Référence	mm ²	mm					Par de apriete Tightening torque Couple de serrage (kg.m)	
		A	BØ	C*	D	E	F	A
LD3B.* -15030	95-150	30	SEGUN NOTA	73	62	92	2	3
LD3B.* -15040	95-150	40		73	67	97	2	3
LD3B.* -15050	95-150	50		73	75	105	2	3
LD3B.* -15060	95-150	60		73	80	110	2	3
LD3B.* -25030	185-250	30		80	62	94	2	3
LD3B.* -25040	185-250	40		80	67	99	2	3
LD3B.* -25050	185-250	50		80	75	107	2	3
LD3B.* -25060	185-250	60		80	80	112	2	3
LD3B.* -40030	300-400	30		85	62	97	2	3
LD3B.* -40040	300-400	40		85	67	102	2	3
LD3B.* -40050	300-400	50		85	75	110	2	3
LD3B.* -40060	300-400	60		85	80	115	2	3
LD3B.* -50030	500	30		94	62	107	3	3
LD3B.* -50040	500	40		94	67	112	3	3
LD3B.* -50050	500	50		94	75	120	3	3
LD3B.* -50060	500	60	94	80	125	3	3	

NOTA: SEPARACION ENTRE CABLES *1=100mm / *15=150mm

NOTE: SPACE BETWEEN CABLES *1=100mm / *15=150mm

NOTE: ÉCARTEMENT DES CABLES *1=100mm / *15=150mm



L CONNECTOR DUPLEX CU. CABLE TO CU. CABLE

CONECTOR A 90° CABLE DUPLEX CU. A CABLE CU.

RACCORD À 90° CABLE DUPLEX CU. À CABLE CU.

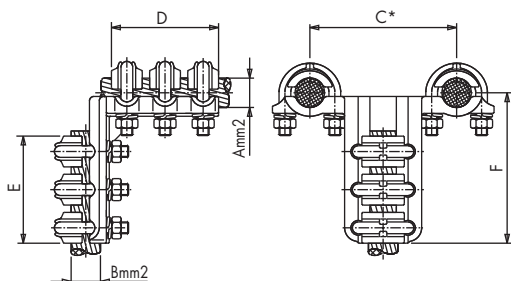

LD3C

Referencia Code Référence	mm ²		mm				Par de apriete Tightening torque Couple de serrage (kg.m)	
	A	B	C*	D	E	F	A	B
LD3C.* -150	95-150	95-150	SEGUN NOTA	73	73	103	2	2
LD3C.* -150250	95-150	185-250		73	80	110	2	2
LD3C.* -150400	95-150	300-400		73	85	115	2	2
LD3C.* -150500	95-150	500		73	94	124	2	3
LD3C.* -250150	185-250	95-150		80	73	105	2	2
LD3C.* -250	185-250	185-250		80	80	112	2	2
LD3C.* -250400	185-250	300-400		80	85	117	2	2
LD3C.* -250500	185-250	500		80	94	126	2	3
LD3C.* -400150	300-400	95-150		85	73	108	2	2
LD3C.* -400250	300-400	185-250		85	80	115	2	2
LD3C.* -400	300-400	300-400		85	85	120	2	2
LD3C.* -400500	300-400	500		85	94	129	2	3
LD3C.* -500150	500	95-150		94	73	118	3	2
LD3C.* -500250	500	185-250		94	80	125	3	2
LD3C.* -500400	500	300-400		94	85	130	3	2
LD3C.* -500	500	500		94	94	139	3	3

NOTA: SEPARACION ENTRE CABLES *1=100mm / *15=150mm

NOTE: SPACE BETWEEN CABLES *1=100mm / *15=150mm

NOTE: ÉCARTEMENT DES CABLES *1=100mm / *15=150mm

L CONNECTOR DUPLEX CABLE TO DUPLEX CABLE

CONECTOR A 90° CABLE DUPLEX A CABLE DUPLEX

RACCORD À 90° CABLE DUPLEX À CABLE DUPLEX

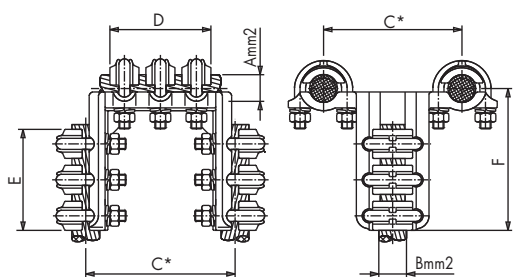

LDX3C

Referencia Code Référence	mm ²		mm				Par de apriete Tightening torque Couple de serrage (kg.m)	
	A	B	C*	D	E	F	A	B
LDX3C.* -150	95-150	95-150	SEGUN NOTA	73	73	103	2	2
LDX3C.* -150250	95-150	185-250		73	80	110	2	2
LDX3C.* -150400	95-150	300-400		73	85	115	2	2
LDX3C.* -150500	95-150	500		73	94	124	2	3
LDX3C.* -250150	185-250	95-150		80	73	105	2	2
LDX3C.* -250	185-250	185-250		80	80	112	2	2
LDX3C.* -250400	185-250	300-400		80	85	117	2	2
LDX3C.* -250500	185-250	500		80	94	126	2	3
LDX3C.* -400150	300-400	95-150		85	73	108	2	2
LDX3C.* -400250	300-400	185-250		85	80	115	2	2
LDX3C.* -400	300-400	300-400		85	85	120	2	2
LDX3C.* -400500	300-400	500		85	94	129	2	3
LDX3C.* -500150	500	95-150		94	73	118	3	2
LDX3C.* -500250	500	185-250		94	80	125	3	2
LDX3C.* -500400	500	300-400		94	85	130	3	2
LDX3C.* -500500	500	500		94	94	139	3	3

NOTA: SEPARACION ENTRE CABLES *1=100mm / *15=150mm

NOTE: SPACE BETWEEN CABLES *1=100mm / *15=150mm

NOTE: ÉCARTEMENT DES CABLES *1=100mm / *15=150mm

L CONNECTOR 90° DUPLEX CU. CABLE TO DUPLEX CABLE

CONECTOR A 90° CABLE DUPLEX CU. A CABLE DUPLEX

RACCORD À 90° CABLE DUPLEX CU. À CABLE DUPLEX

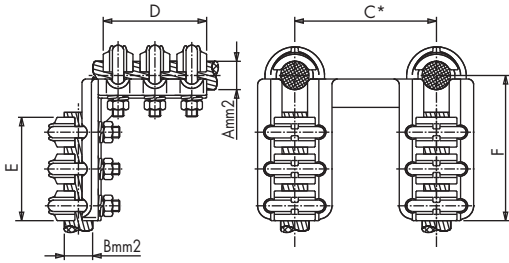

LDD3C

Referencia Code Référence	mm ²		mm				Par de apriete Tightening torque Couple de serrage (kg.m)	
	A	B	C*	D	E	F	A	B
				SEGUN NOTA				
LDD3C.* -150	95-150	95-150		73	73	103	2	2
LDD3C.* -150250	95-150	185-250		73	80	110	2	2
LDD3C.* -150400	95-150	300-400		73	85	115	2	2
LDD3C.* -150500	95-150	500		73	94	124	2	3
LDD3C.* -250150	185-250	95-150		80	73	105	2	2
LDD3C.* -250	185-250	185-250		80	80	112	2	2
LDD3C.* -250400	185-250	300-400		80	85	117	2	2
LDD3C.* -250500	185-250	500		80	94	126	2	3
LDD3C.* -400150	300-400	95-150		85	73	108	2	2
LDD3C.* -400250	300-400	185-250		85	80	115	2	2
LDD3C.* -400	300-400	300-400		85	85	120	2	2
LDD3C.* -400500	300-400	500		85	94	128	2	3
LDD3C.* -500150	500	95-150		94	73	118	3	2
LDD3C.* -500250	500	185-250		94	80	125	3	2
LDD3C.* -500400	500	300-400		94	85	130	3	2
LDD3C.* -500	500	500		94	94	139	3	3

NOTA: SEPARACION ENTRE CABLES *1=100mm / *15=150mm

NOTE: SPACE BETWEEN CABLES *1=100mm / *15=150mm

NOTE: ÉCARTEMENT DES CABLES *1=100mm / *15=150mm

L CONNECTOR DUPLEX CU. TUBES TO CU. CABLE

CONECTOR A 90° TUBOS DUPLEX CU. A CABLE CU.

RACCORD À 90° TUBES DUPLEX CU. À CABLE CU.

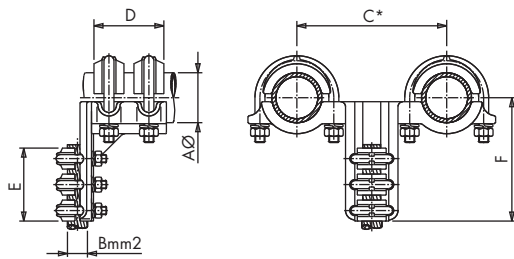

LDBC3

Referencia Code Référence	Aø	mm ²	mm				Par de apriete Tightening torque Couple de serrage (kg.m)	
			B	C*	D	E	F	A
					SEGUN NOTA			
LDBC3.* -30150	30	95-150		62	73	116	3	2
LDBC3.* -30250	30	185-250		62	80	123	3	2
LDBC3.* -30400	30	300-400		62	85	128	3	2
LDBC3.* -30500	30	500		62	94	137	3	3
LDBC3.* -40150	40	95-150		67	73	121	3	2
LDBC3.* -40250	40	185-250		67	80	128	3	2
LDBC3.* -40400	40	300-400		67	85	133	3	2
LDBC3.* -40500	40	500		67	94	142	3	3
LDBC3.* -50150	50	95-150		75	73	128	3	2
LDBC3.* -50250	50	185-250		75	80	135	3	2
LDBC3.* -50400	50	300-400		75	85	140	3	2
LDBC3.* -50500	50	500		75	94	149	3	3

NOTA: SEPARACION ENTRE CABLES *1=100mm / *15=150mm

NOTE: SPACE BETWEEN CABLES *1=100mm / *15=150mm

NOTE: ÉCARTEMENT DES CABLES *1=100mm / *15=150mm

L CONNECTOR DUPLEX CU. TUBES TO CU. TUBE

CONECTOR A 90º TUBOS DUPLEX CU. A TUBO CU.

RACCORD À 90º TUBES DUPLEX CU. À TUBE CU.

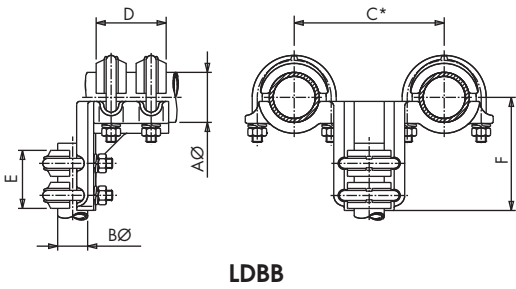

Referencia Code Référence	mm						Par de apriete Tightening torque Couple de serrage (kg.m)
	AØ	BØ	C*	D	E	F	
LDBB.*-3030	30	30	SEGUN NOTA	62	62	105	3
LDBB.*-3040	30	40		62	67	110	3
LDBB.*-3050	30	50		62	75	118	3
LDBB.*-4030	40	30		67	62	110	3
LDBB.*-4040	40	40		67	67	115	3
LDBB.*-4050	40	50		67	75	123	3
LDBB.*-5030	50	30		75	62	117	3
LDBB.*-5040	50	40		75	67	122	3
LDBB.*-5050	50	50		75	75	130	3

NOTA: SEPARACION ENTRE CABLES *1=100mm / *15=150mm

NOTE: SPACE BETWEEN CABLES *1=100mm / *15=150mm

NOTE: ÉCARTEMENT DES CABLES *1=100mm / *15=150mm